

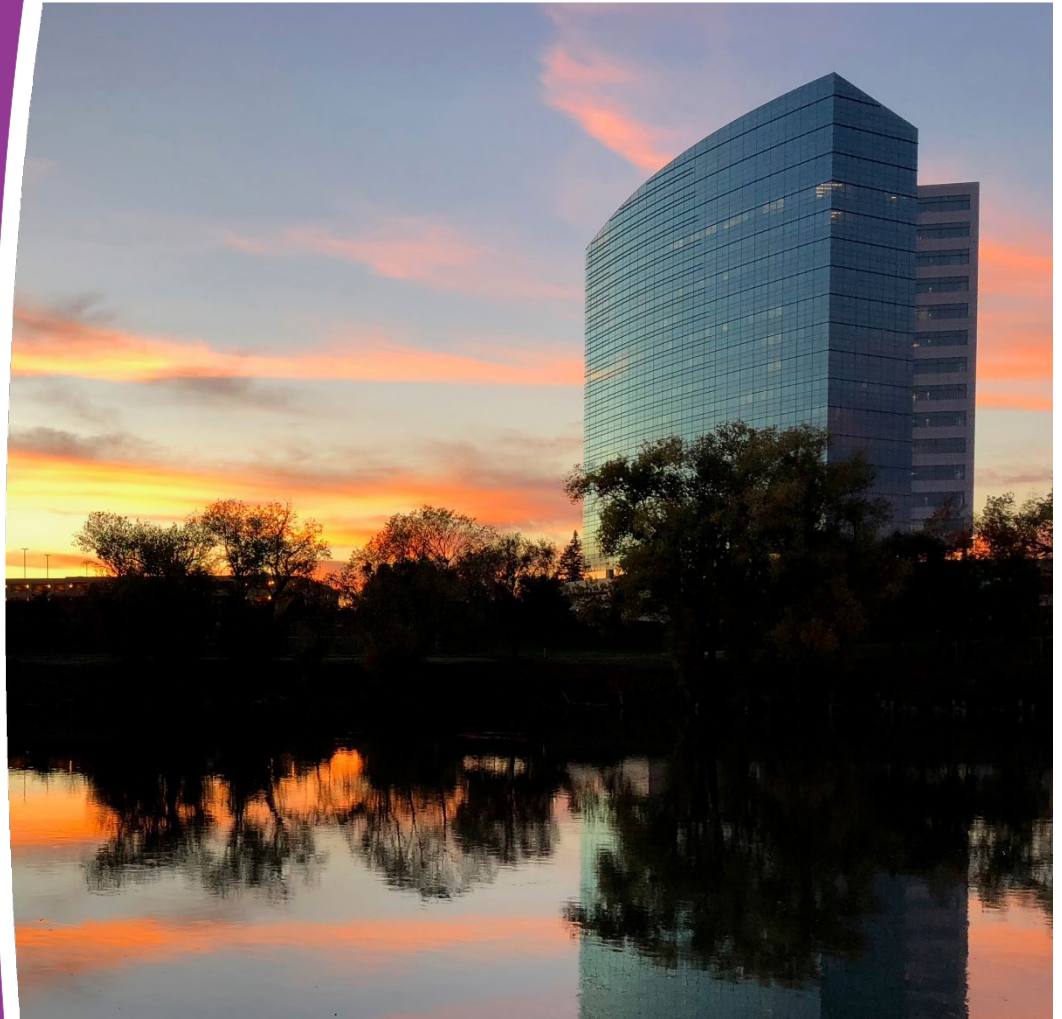

# Enterprise Technology Projects

FISCAL YEAR

2021-22



**THIRD QUARTER REPORT**

Quarter Ending March 31, 2022

## ENTERPRISE TECHNOLOGY PROJECTS

FISCAL YEAR 2021-22  
THIRD QUARTER REPORT

At the end of the third quarter for fiscal year 2021-22, CalSTRS had eight enterprise projects: six major technology projects over \$1 million and two additional projects under \$1 million.

The Project Support Office monitors and reports monthly on the technology appropriations budget and enterprise projects' status to the Enterprise Program Investment Council and quarterly to the Teachers' Retirement Board.

## ENTERPRISE PROGRAM INVESTMENT COUNCIL MEMBERS

**Cassandra Lichnock**

Chief Executive Officer

**Lisa Blatnick**

Chief Operating Officer

**Julie Underwood**

Chief Financial Officer

**Melissa Norcia**

Chief Administrative Officer

**Teresa Schilling**

Chief Public Affairs Officer

**Ashish Jain**

Chief Technology Officer

**Bill Perez**













Chief Benefits Officer

**Scott Chan**

Deputy Chief Investment Officer

## MAJOR ENTERPRISE TECHNOLOGY PROJECTS

The following table summarizes current major enterprise technology projects during the third quarter.

Project Name	Project Duration	Schedule (Status)	Project Budget <sup>1</sup>	Budget Expended <sup>2</sup>	Budget (Status)
BusinessDirect Retrofit	Apr 2017 <sup>3</sup> – Jan 2023 <sup>4</sup>	 <sup>5</sup>	\$9,769,238 <sup>6</sup>	\$5,636,181	
Data Quality	Nov 2011 – Jun 2022		\$30,910,879	\$27,197,134	
Datacenter Hosting and Migration Services	Nov 2020 – Oct 2023		\$19,900,000	\$5,601,858	
HR Link	Dec 2018 – Jun 2022		\$2,469,315	\$909,600	
Pension Solution	Jul 2014 <sup>7</sup> – Jan 2023	 <sup>8</sup>	\$304,833,040	\$223,043,893	
Transformation Readiness	Jul 2016 – Jun 2022		\$18,356,368	\$15,796,455	

*Schedule & Budget Indicators*  *On Track*  *Warning*  *Critical*  *Complete*  *Cancelled*  *Not Started*

<sup>1</sup> Project Budget – Amount represents the sum of the projects' prior years' actual expended, remaining encumbrances, and current and future years budgeted amounts.

<sup>2</sup> Budget Expended – Amount represents the total expended.

<sup>3</sup> BusinessDirect Retrofit – Project Start Date was revised to reflect its original approval date. Prior to October 2019, it was funded solely by the Pension Solution project.

<sup>4</sup> BusinessDirect Retrofit – The project end date was changed to coincide with the current approved end date for Pension Solution. It will be updated again to align with the Pension Solution project schedule (when approved).

<sup>5</sup> BusinessDirect Retrofit – The schedule is dependent on the implementation schedule for the Pension Solution Project.

<sup>6</sup> BusinessDirect Retrofit – In addition to the amount reported above, the Pension Solution Project is providing \$5.4 Million funding for system enhancements to pension administration-related functionality.

<sup>7</sup> Pension Solution – Project Start Date represents the effective date of the first comprehensive project budget approved by the Teachers' Retirement Board and when the Budget Change Proposal approved by the Department of Finance and included in the Governor's budget became available. Pre-implementation (Discovery, Requirements, and Procurement) began in 2010.

<sup>8</sup> Pension Solution – The red indicator is due to the vendor experiencing significant delays with Contractor Acceptance Testing - Part B for Functional Rollout 2. CalSTRS is also experiencing a lower-than-expected pass rate in User Acceptance Testing. Additionally, the vendor is making slower progress in fixing the defects than anticipated. The delayed completion is impacting the project schedule and all downstream project activities including User Acceptance Testing and the Go-Live dates for both FR2 and FR3.

## MAJOR ENTERPRISE TECHNOLOGY PROJECTS

### BUSINESSDIRECT RETROFIT

The BusinessDirect Retrofit project goals and objectives are to support CalSTRS in the implementation of a new pension administration system, BenefitConnect. This will be accomplished by modifying BD to migrate specific pension functionality out of BD and into BC, building new interfaces between BD and BC, modifying some existing interfaces between BD and BC and external entities, and extracting/mapping historical data from BD to BC to support functionality migration.

NOTE: The schedule for this project is dependent on the Pension Solution Project schedule. For this reason, it is unknown at this time what major activities and milestones (aside from those shown below) are expected to be completed during the next quarter. A Change Request was approved to release external project resources at the end of Q3 due to unknown scheduling of upstream activities and milestones.

#### PROJECT BUDGET

\$9.8 Million

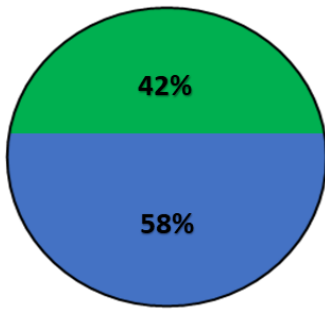

● % Expended ● % Remaining

#### ACCOMPLISHMENTS – PERIOD ENDING MARCH 31, 2022

- Passed 94% of test cases for Functional Rollout 2 Integration Testing.
- Passed 25% of test cases for FR2 Parallel Testing.
- Passed 47% of test cases for User Acceptance Testing.
- Completed UAT traceability matrix (deliverable) for the Financial Services Branch.
- Completed Performance Test activities and related deliverables.
- Completed Data Conversion Test activities and related deliverables.
- Established a Detailed Cutover Plan (pending upstream schedule).

#### PLANNED MAJOR ACTIVITIES & MILESTONES BY JUNE 30, 2022

- Complete FR2 Integration Test activities and related deliverables.

#### PROJECT SCHEDULE STATUS TIMELINE

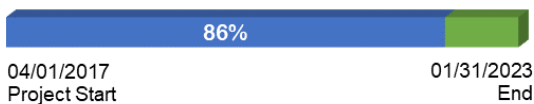

#### FISCAL YEAR 2021–22 MAJOR MILESTONES

Because the schedule for this project is dependent on the Pension Solution Project schedule, the expected milestone dates are not fully known until the schedule for the Pension Solution Project has been reforecast.

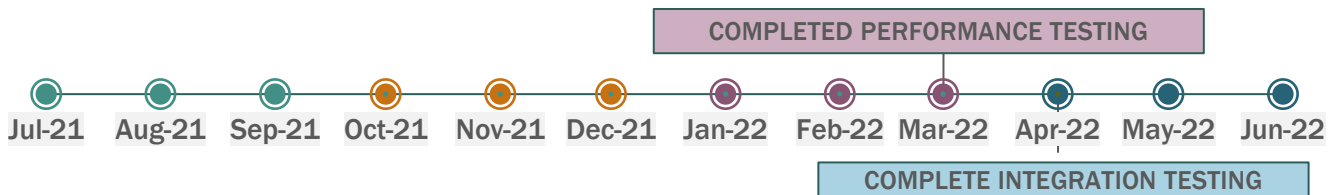

## MAJOR ENTERPRISE TECHNOLOGY PROJECTS

### DATA QUALITY

The Data Quality project is in the second phase of data cleansing to include data clean-up and preparation for conversion to the new pension administration system.

NOTE: The schedule for this project is dependent on the Pension Solution Project schedule, for which, as noted in this report, a complete schedule and budget (including milestones, cost, and staffing) analysis is being conducted. A Change Request is being prepared to align Data Quality with the proposed schedule for Pension Solution, once it is known, to continue rerunning data fixes, triage and resolve conversion fallout, and support Data Validation.

#### PROJECT BUDGET

\$30.9 Million

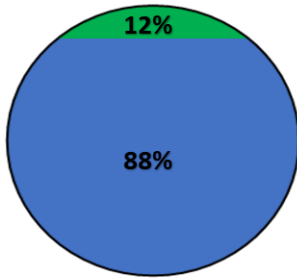

● % Expended ● % Remaining

#### ACCOMPLISHMENTS – PERIOD ENDING MARCH 31, 2022

- Completed one Conversion Fallout Issue.
- Reran Archive Flag (Rerun #1).

#### PLANNED MAJOR ACTIVITIES & MILESTONES BY JUNE 30, 2022

- Rerun Member Lifecycle Fix A.
- Rerun Member Life Cycle Fix B and D.
- Complete Change Request to extend Data Quality to align with the proposed Pension Solution schedule once it is known.

#### PROJECT SCHEDULE STATUS TIMELINE

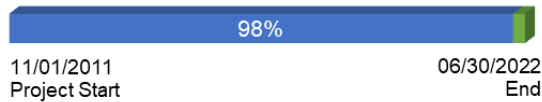

#### FISCAL YEAR 2021-22 MAJOR MILESTONES<sup>9</sup>

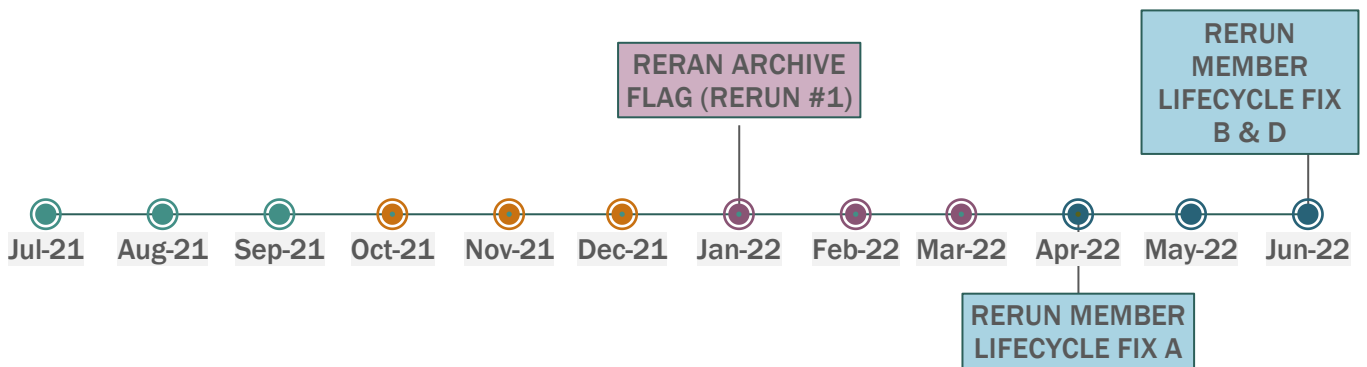

<sup>9</sup> As approved by Pension Solution Steering Committee.

## MAJOR ENTERPRISE TECHNOLOGY PROJECTS

### DATACENTER HOSTING AND MIGRATION SERVICES

The Datacenter Hosting and Migration Services project will enable CalSTRS to mitigate the business continuity risks, supports CalSTRS enterprise strategic goals, and establishes a flexible framework for operational efficiency and cost optimization through the migration of on-premise critical systems/equipment onto a multi-modal data center solution.

#### PROJECT BUDGET

\$19.9 Million

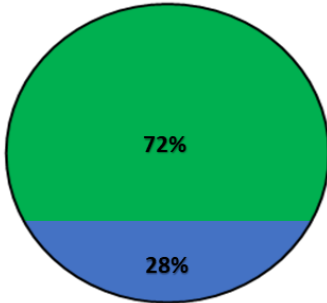

● % Expended ● % Remaining

#### ACCOMPLISHMENTS – PERIOD ENDING MARCH 31, 2022

- There are no major accomplishments during the reporting period.

#### PLANNED MAJOR ACTIVITIES & MILESTONES BY JUNE 30, 2022

- Complete the migration of the Electronic Content Management System and related Connectors, BusinessDirect and related Connectors, Investment CPEs, and Contact Center solutions.
- Redesign & Build of the VMware Horizon/VDI remote access solution to meet CalSTRS Disaster Recovery requirements.

#### PROJECT SCHEDULE STATUS TIMELINE



#### FISCAL YEAR 2021–22 MAJOR MILESTONES

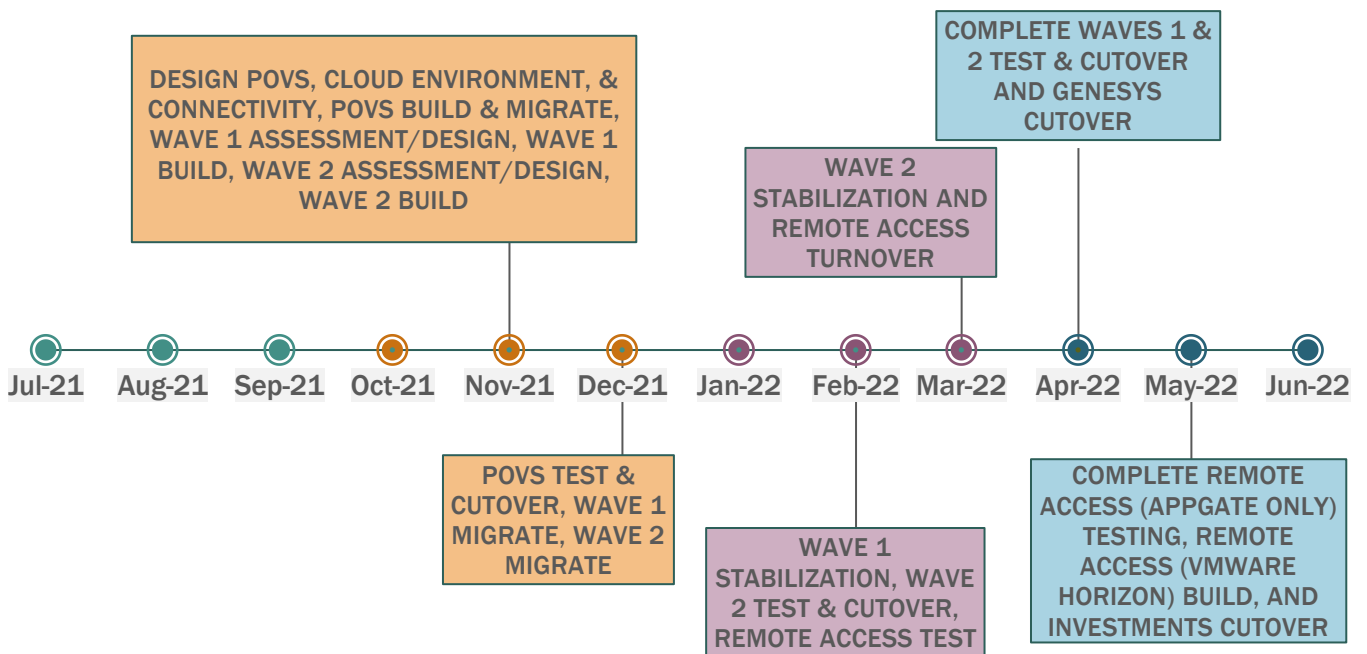

## MAJOR ENTERPRISE TECHNOLOGY PROJECTS

### HR LINK

The HR Link project will improve efficiencies by automating Human Resource processes, delivering real-time data and a self-service platform for all CalSTRS staff. The solution includes a core HR platform and tools for time management, learning and development, performance and goals, succession planning, onboarding, workforce planning and analytics. This is a multi-year project that will be implemented in phases. Employee Central and Learning and Development are the first modules and include a core HR platform, time and attendance management, and a learning management system.

#### PROJECT BUDGET

\$2.5 Million

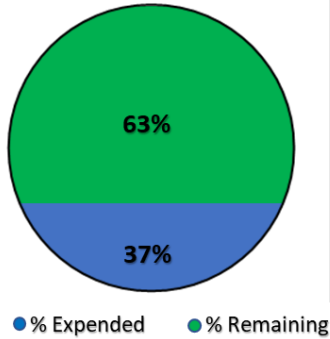

#### ACCOMPLISHMENTS – PERIOD ENDING MARCH 31, 2022

- All Testing was completed.
- Training delivery began.
- Cutover activities for Phase 1 modules began.
- Change Request to extend through June 30, 2022 is complete.
- First level demos for time and attendance solutions were completed.

#### PLANNED MAJOR ACTIVITIES & MILESTONES BY JUNE 30, 2022

- Phase 1 go-live.
- Complete Phase 2 Change Request.

#### PROJECT SCHEDULE STATUS TIMELINE

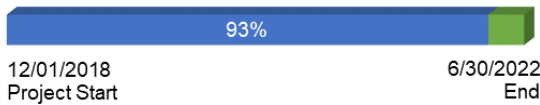

#### FISCAL YEAR 2021–22 MAJOR MILESTONES

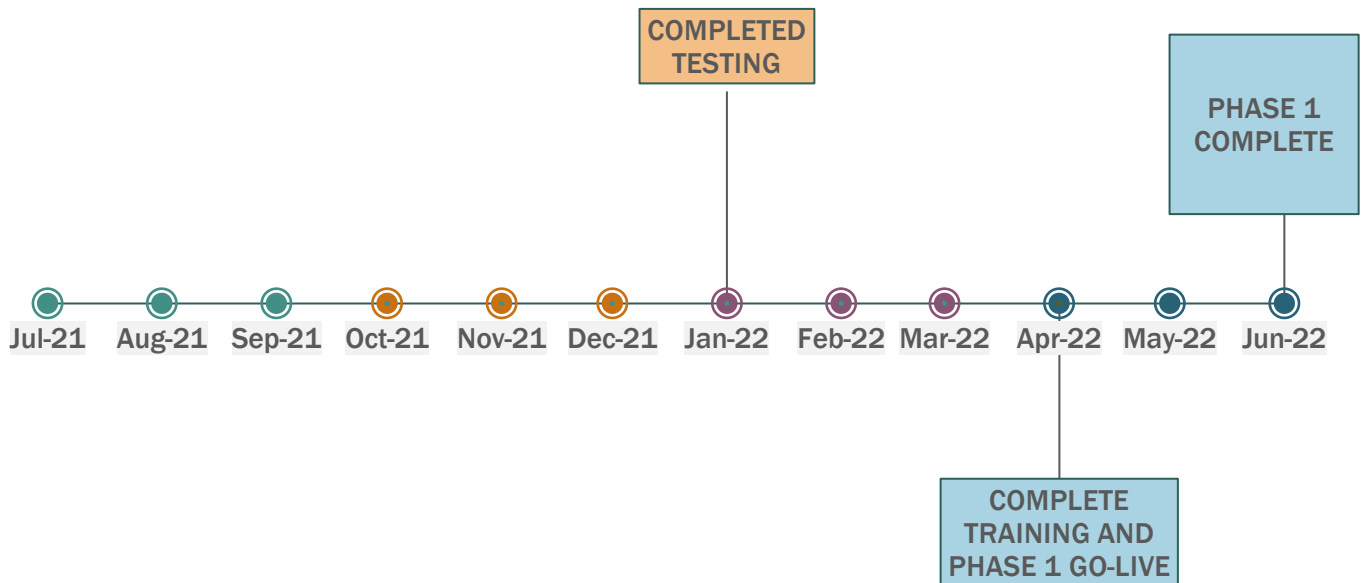

## MAJOR ENTERPRISE TECHNOLOGY PROJECTS

### PENSION SOLUTION

The Pension Solution Project will replace the CalSTRS legacy pension administration system to increase the organization's ability to respond to business and customer needs; enhance services to members, beneficiaries, staff and employers; gain long-term operational efficiencies; and improve internal controls.

NOTE: The project is in negotiation with the vendor and CalSTRS executive staff to determine the schedule and scope for the remainder of the project. A Change Request is expected to be submitted once negotiation is complete. Once the CR is approved, the timelines below will be updated.

#### PROJECT BUDGET

\$304.8 Million

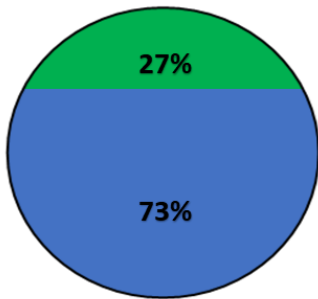

● % Expended ● % Remaining

#### ACCOMPLISHMENTS – PERIOD ENDING MARCH 31, 2022

- Passed 3,427 of 7,095 executed test runs for Functional Rollout 2 User Acceptance Testing.

#### PLANNED MAJOR ACTIVITIES & MILESTONES BY JUNE 30, 2022

- Complete Contractor Acceptance Testing (Part-B) for Functional Rollout 2.
- Provide details of the schedule replanning effort and adjustments to the remaining project tasks and milestones.

#### PROJECT SCHEDULE STATUS TIMELINE

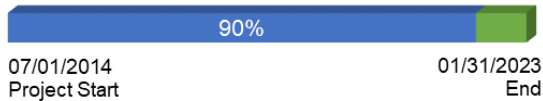

#### FISCAL YEAR 2021-22 MAJOR MILESTONES

NOTE: Milestones will be added after the schedule replanning efforts are finalized.

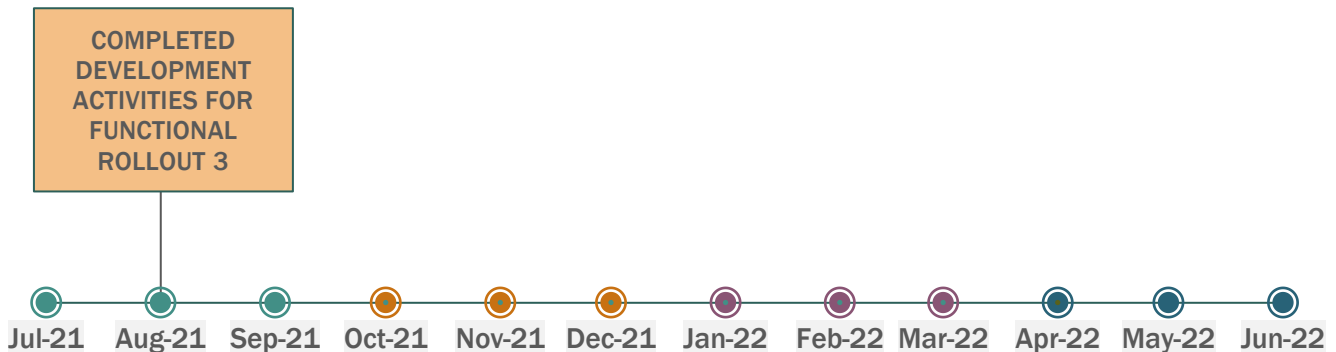



## MAJOR ENTERPRISE TECHNOLOGY PROJECTS

### TRANSFORMATION READINESS

The Transformation Readiness project supports business areas and prepares staff for impacts, changes, and benefits from large enterprise modernization efforts.

NOTE: The schedule for this project is dependent on the Pension Solution Project schedule. For this reason, it is unknown at this time what major activities and milestones (aside from those shown below) are expected to be completed during the next quarter.

#### PROJECT BUDGET

\$18.4 Million

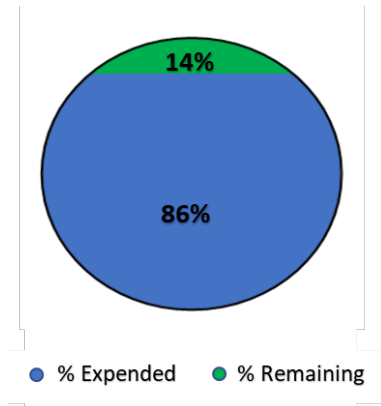

#### ACCOMPLISHMENTS – PERIOD ENDING MARCH 31, 2022

- Conducted activities to increase organizational awareness of project.
- Added tools to toolkit for leaders to help address change fatigue.
- Developed MS Teams channel for change champions to enhance collaboration.

#### PLANNED MAJOR ACTIVITIES & MILESTONES BY JUNE 30, 2022

- Launch MS Teams channel for change champions to enhance collaboration.
- Continue to collaborate with Project Leadership to develop frequent and transparent communication about the current project status and ongoing potential adjustments.
- Deliver Functional Rollout 3 training analysis for business area review.
- Deliver Change Leadership Toolkit to change champions and change leaders.
- Finalize Pension Solution overview materials shared at new employee onboarding.

#### PROJECT SCHEDULE STATUS TIMELINE

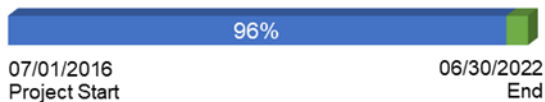

#### FISCAL YEAR 2021-22 MAJOR MILESTONES

Because the schedule for this project is dependent on the Pension Solution Project schedule, the expected milestone dates are unknown until the schedule for the Pension Solution Project has been reforecast.



## OTHER ENTERPRISE PROJECTS UNDER \$1 MILLION

The following table summarizes other reportable enterprise projects under \$1 million during the third quarter.

Project and Description	Project Duration	Schedule (Status)	Project Budget <sup>10</sup>	Budget Expended <sup>11</sup>	Budget (Status)
<b>CalSTRS.com Modernization</b> Provides CalSTRS with a modern public-facing website that meets the latest web architecture standards and caters to members, investors, and all other CalSTRS business partners' needs.	Sep 2020 – Apr 2022	✓	\$678,123	\$221,203	✓
<b>Print to Mail Software</b> Install and integrate Pitney Bowes print-to-mail software, Planet Press, between the new pension administration system and our centralized printer. Provides the ability to process outgoing member correspondence in zip code order and varying page-counts, to align with how it is generated by BenefitConnect. Provides a modern print-to-mail software solution with more automated workflow and built-in security oversight protections and risk-mitigation measures.	Dec 2020 – Oct 2021	🚫 <sup>12</sup>	\$559,283	\$130,310	🎯

Schedule & Budget Indicators   🎯 On Track   ⚠️ Warning   🚫 Critical   ✓ Complete   ✕ Cancelled   🕒 Not Started

<sup>10</sup> Project Budget – Amount represents the sum of the projects' prior years' actual expended, remaining encumbrances, and current and future years budgeted amounts.

<sup>11</sup> Budget Expended – Amount represents the total expended.

<sup>12</sup> Print to Mail Software Schedule – The schedule is dependent on the implementation schedule for the Pension Solution Project.